

JVP180-11
Kits
AS0

Numatic

numatic.com

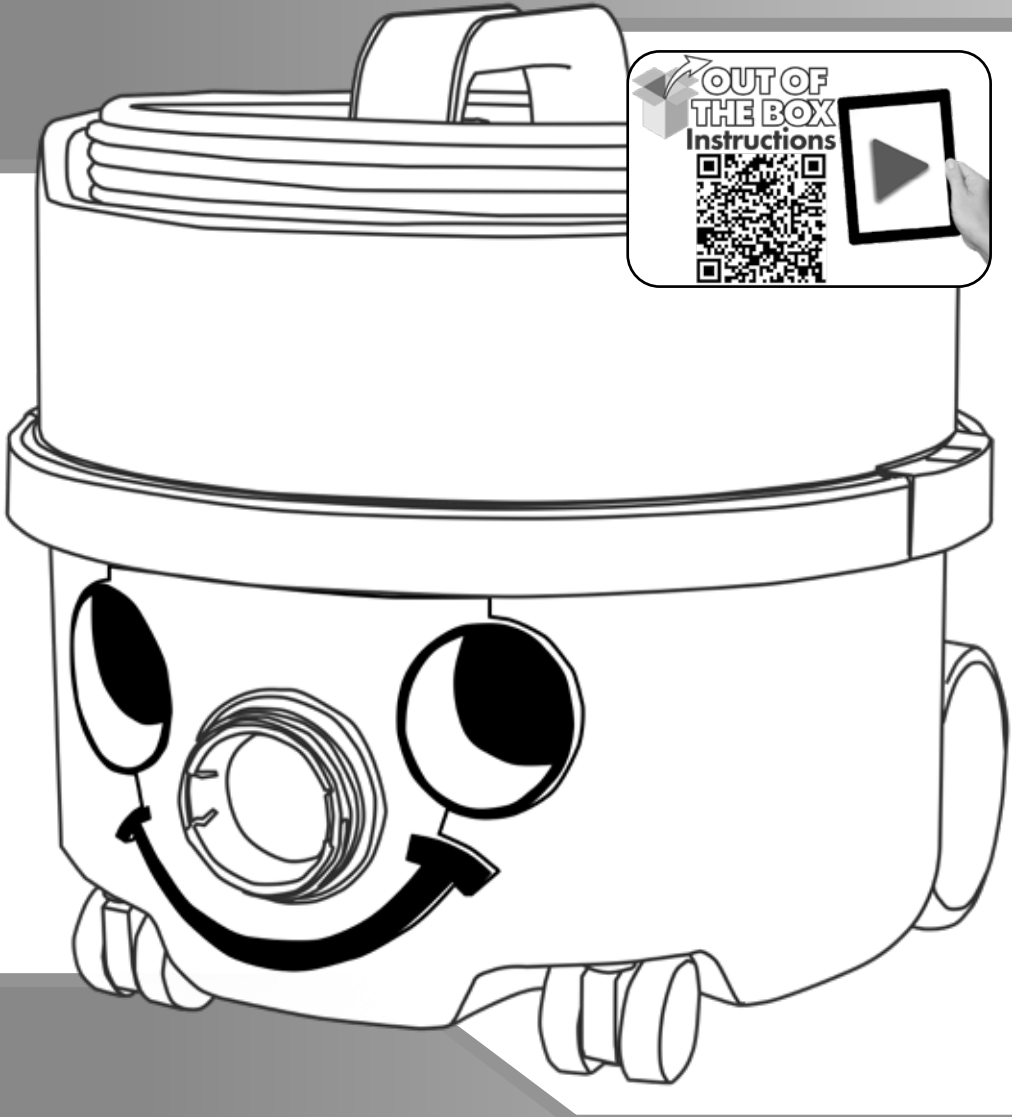

Original Instructions

CAUTION, Read the Instructions before using the machine.

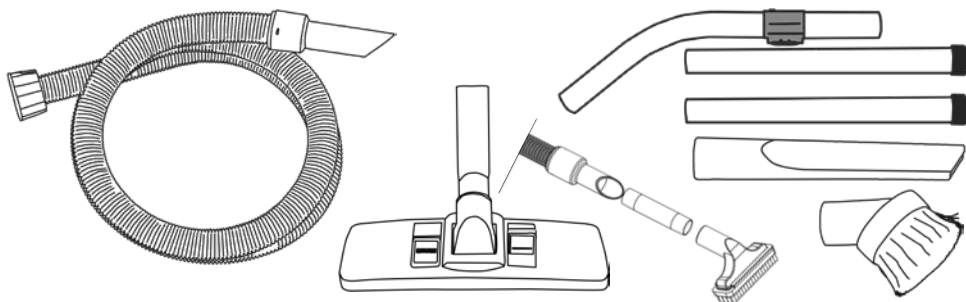

Assembly

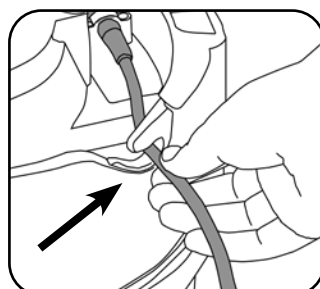
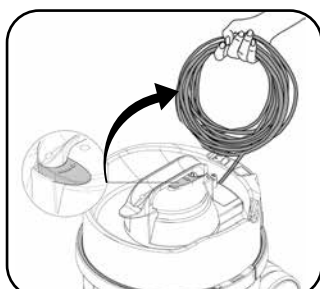
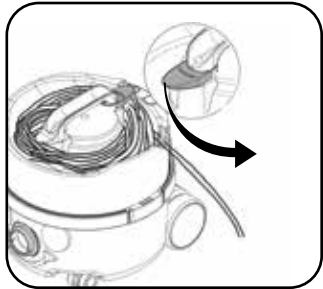
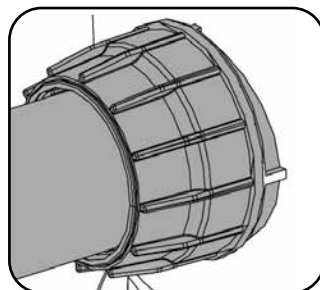
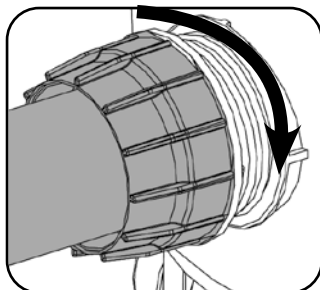
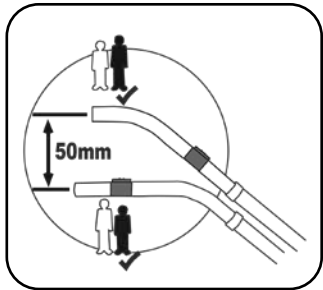
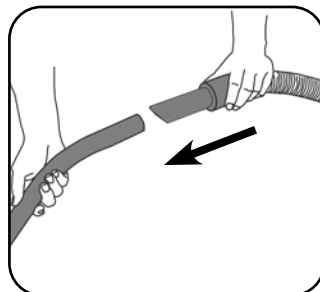
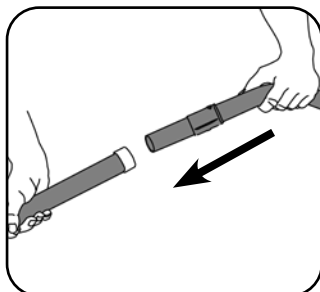
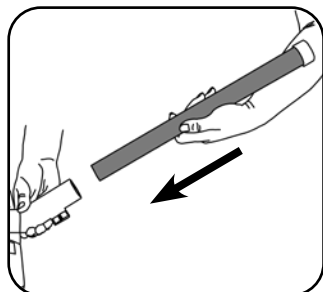

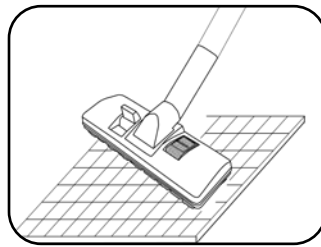
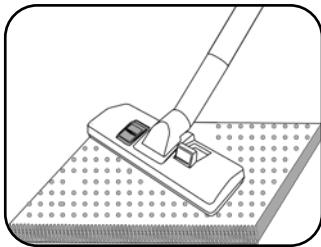
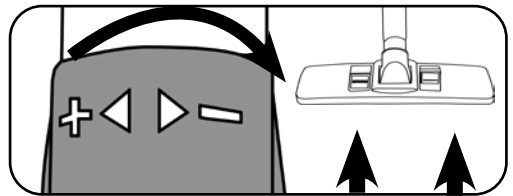
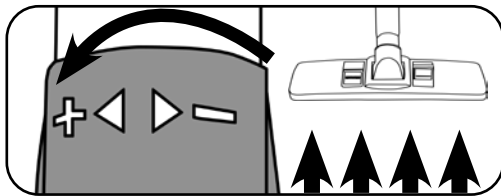
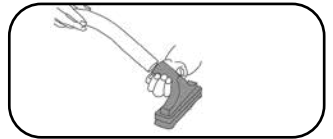
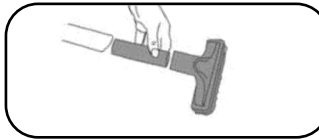
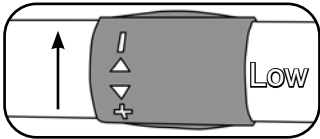
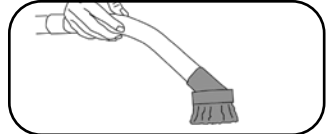
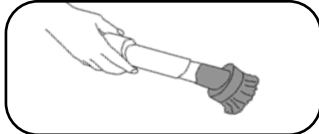
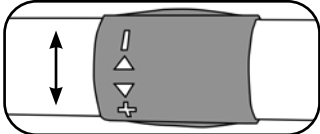
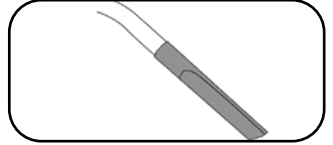
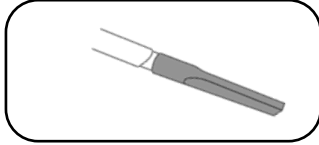
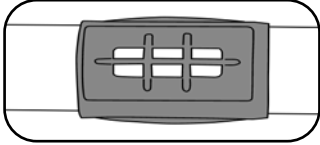
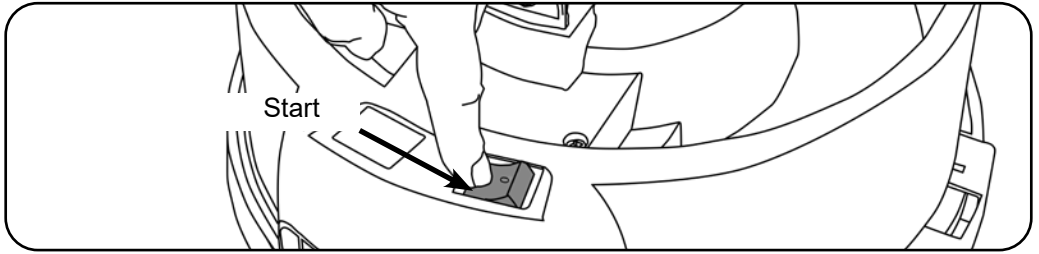

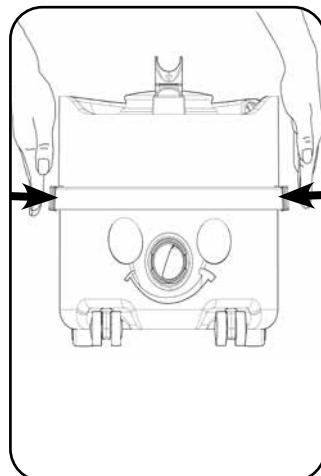
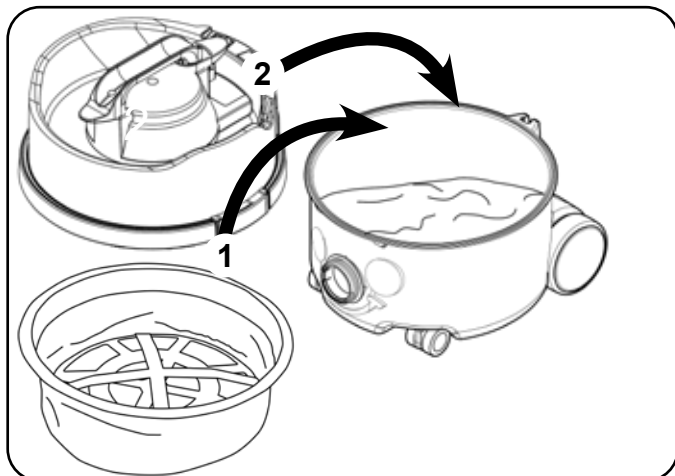
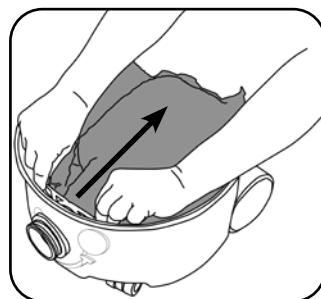
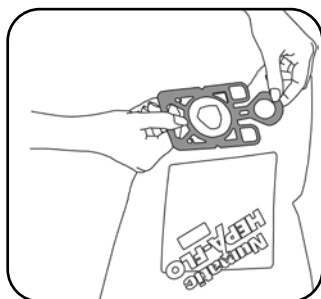
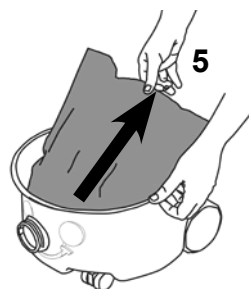
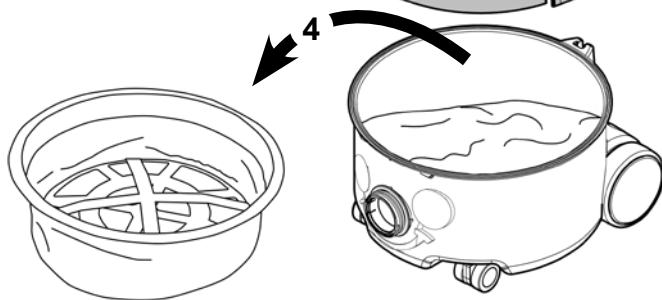
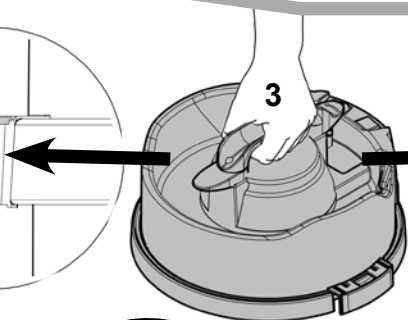
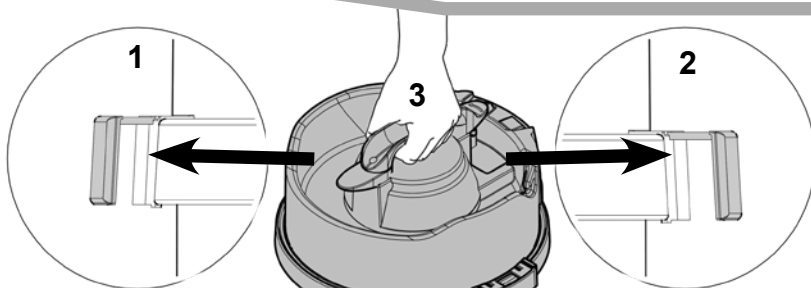

Fitting the Face

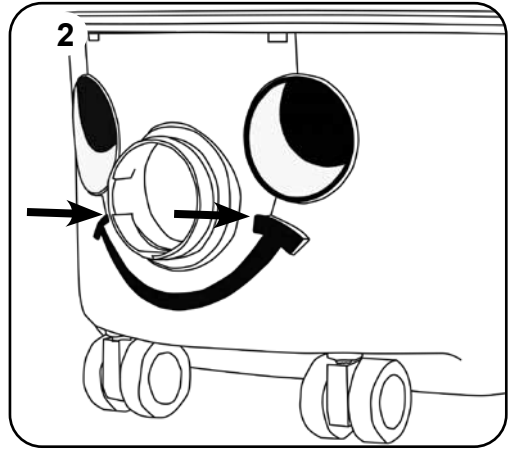
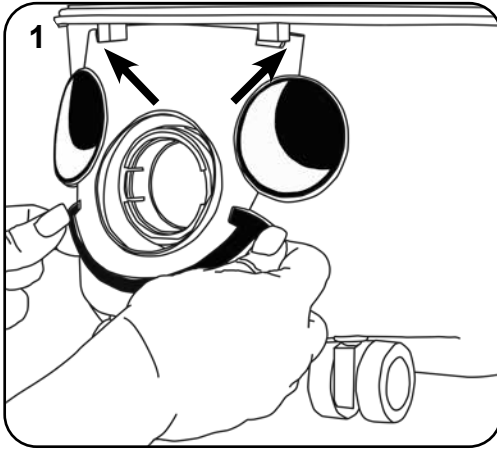

Removing the Face

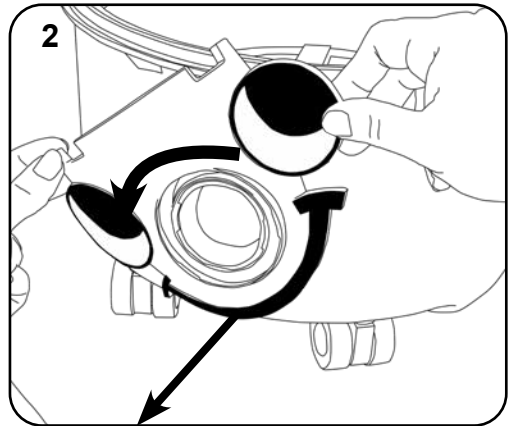
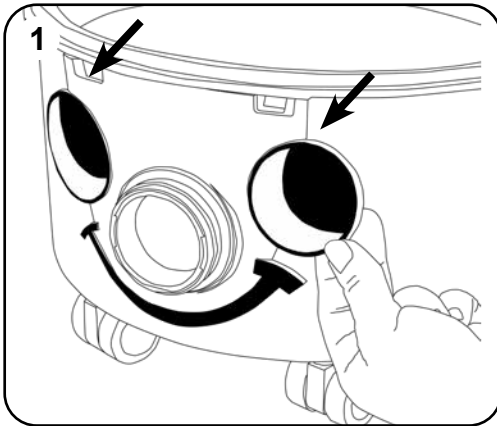

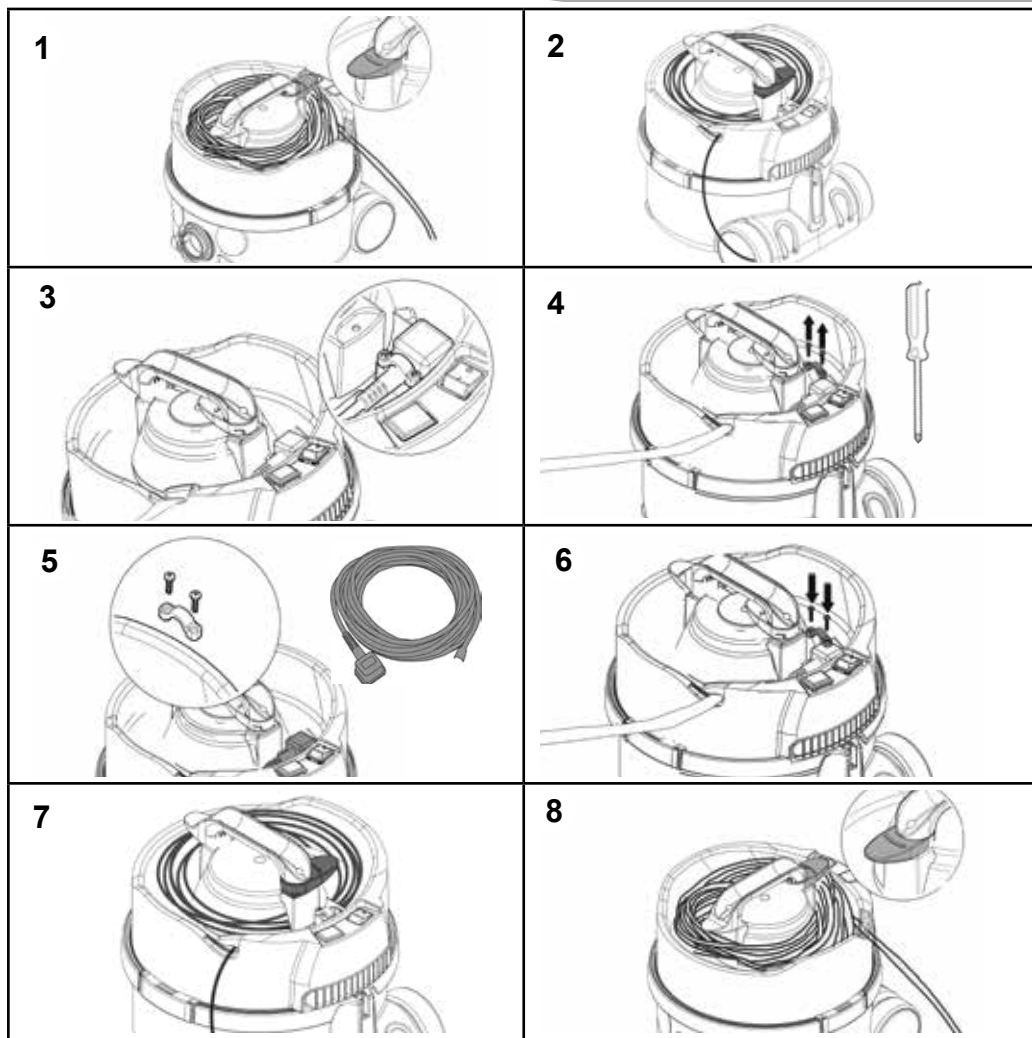

Wand docking / Tool Tidy

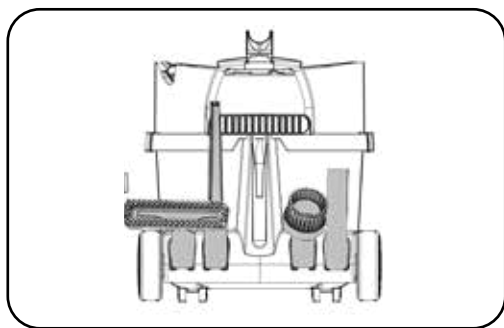
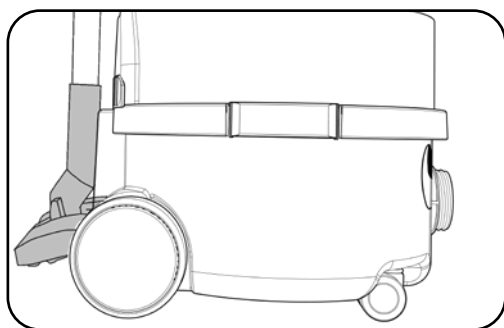

1	Company Name & Address
2	Model
3	Voltage / Alternating Current
4	Frequency
5	Rated Input Power
6	Weight
7	WEEE Logo
8	Protection Class 2 Symbol
9	Approval Mark
10	Machine yr/wk Serial Number

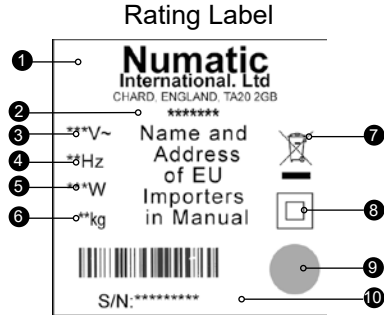

Daily
 Keep the machine clean, including hoses and tubes.
 Ensure the bag and filter are fitted.
 Regularly examine the power cord.
 Check dust bag frequently.
 Check filters are clean.

Weekly - as daily and:-
 Check for any worn or damaged parts and replace immediately.

Maintenance

WEEE Legislation (Waste, Electrical and Electronic Equipment)
 Vacuum cleaner, accessories and packaging should be sorted for environmentally - friendly recycling.

(Only for UK/EU Countries)
 Do not dispose of vacuum cleaner into household waste! According to the European Directive 2012/19/EU on waste electrical and electronic equipment and its incorporation into national law. Vacuum cleaners that are no longer suitable for use must be separately collected and sent for recovery in an environmentally - friendly manner.



PPE (personal protective equipment). That may be required for certain operations.

Ear Protection	Safety Footwear	Head Protection	Safety Gloves	
Eye Protection	Protective Clothing	Dust / Allergens Protection	Hi Viz Jacket	

NOTE: A risk assessment should be conducted to determine which PPE should be worn.

Failure to rectify the problem or in the event of a breakdown contact your Numatic dealer or the Numatic Technical helpline +44 (0)1460 269268

Safety Critical Components
 HO5-VV-F 10 m x 2 Core x 1.00 mm²

Mains leads:

WARNING

Read the instruction manual before using the machine.

Operators shall be adequately instructed on the use of their machine.

As with all electrical equipment, care and attention must be exercised at all times during use, in addition to ensuring that routine and preventative maintenance is carried out periodically to ensure safe operation.

Failure to carry out maintenance as necessary, including the replacement of parts to the correct standard could render this equipment unsafe and the manufacturer can accept no responsibility in this respect.

Maintenance should only be carried out by a qualified person.

This machine is for DRY USE only and must not be stored outside or used in wet conditions.

The machine shall be disconnected from the mains power by removing the plug from the power supply socket during cleaning or maintenance and when replacing parts or converting the machine to another function.

Only use the socket outlet on the machine for purposes specified in the instructions (if fitted).

This machine is not to be used by children or persons with reduced physical, sensory or mental capabilities, or lack of experience or knowledge.

This appliance is intended to be cleaned and maintained by an adult.

Children being supervised are not to play with the machine.

This machine is not a toy.

This machine is not suitable for picking up hazardous or explosive dust.

Contact your local distributor if you require a machine capable of performing these tasks.

CAUTION

Ensure that the filtration system fitted to the machine is suitable for the material being collected.

This vacuum cleaner is intended for indoor use in the collection of dry materials.

This machine should be stored indoors only.

NOTES

The primary use for this machine is commercial, for example in hotels, schools, hospitals, factories, shops and offices.

This product complies with the requirements of clause 20 of IEC/EN 60335-2-69 Stability and Mechanical Hazards.

This vacuum cleaner is fitted with a thermal protection device. If the vacuum cleaner stops working, remove the plug from the wall before investigating where the fault lies.

If the vacuum cleaner has a blockage, switch off, remove the plug from the power socket, inspect the floor tool, tubes and hose for debris. If the floor tool, tubes and hose are clear, replace the dust bag and clean the filter.

The vacuum cleaner should be inspected after use for damage.

The vacuum cleaner should be stored in a dry place.

When moving from one place to another, consider the weight of the machine.

DO

- Keep your machine clean including hoses and tubes.
- Change dust bag frequently.
- Keep filters clean.
- Keep diffuser filter (where fitted) clean.
- Use filter bags, they will enhance performance and help keep machine clean.
- Use a Numatic Original filter bag under fine dust conditions.
- Keep hoses and tubes clear.
- Replace any worn or damaged parts immediately.
- Only use the brushes provided with the machine. The use of other brushes may impair safety.
- Regularly examine the power cord. If damage is found such as cracking or ageing the power cord must be replaced by a qualified person.
- Only replace the power cord with the correct Numatic approved replacement part.

DO NOT

- Pull on the cable to unplug the machine from the power supply.
- Use to suck up hot ashes or lighted cigarette ends.
- Use steam cleaners or pressure washers to clean the machine or use in the rain.
- Immerse in water for cleaning.
- Attempt machine maintenance or cleaning unless the power supply plug has been removed from the supply outlet.
- Use in wet environments or to collect wet materials.
- Under any circumstances place foreign objects including (but not limited to) air fresheners, air freshener capsules or scented beads of any type into the top filter of the machine. Doing so can be dangerous and risk damage to the machine and may invalidate the machine warranty.

Schematic Diagram

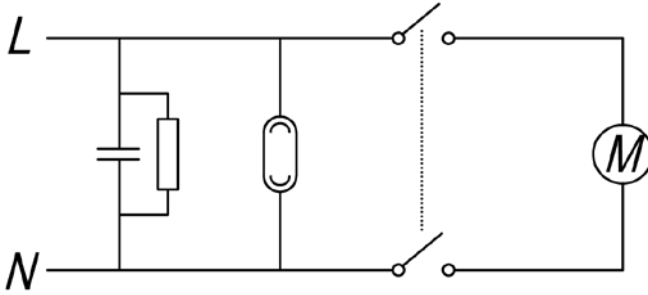

Replacement parts

TriTex Filter, Primärfilter, Filter, Filter

604165

TriTex Filter

HepaFlo Dust Bags, Gleitschiene, Filtre, Zakken

909291

NVM 1CH (Pack of 3)

907076

NVM 1CH (Pack of 5)

907075

NVM 1CH (Pack of 10)

Data

1	2	3	4	5	6
8 L	26.0m	6.0 kg	70.3 dB (A) 0.5 dB	Class II	340 mm x 365 mm x 360 mm

1	2	3	4	5	6
Drum Size	Cleaning Range	Weight (Ready to work)	Sound Pressure (LpA) Uncertainty (KpA)	Protection Class	Dimensions

Numatic International Warranty

Numatic International Limited warrant to the original purchaser that its products are free of defects in both material or workmanship for the period shown below:-

Homecare and Cleancare Vacuum cleaners.....	2 Years
Rotary Floor Machines.....	2 Years
Twintec Auto Scrubber Dryer.....	1 Year
Vario Ride-On Scrubber Dryer.....	1 Year / 1500 hours
Mopping, Compacts, Combi and Servocare Products.....	1 Year
Individual Accessories and Spare Parts.....	6 Months

Note: This warranty expressly excludes consumable parts such as carbon brushes, floor brushes, mops, batteries etc, that are considered replaceable from time to time during the normal working life of the machine.

Using non Numatic dustbags can be detrimental to both machine performance and life and may invalidate the Warranty.

A. The warranty period commences from the date the goods are purchased.

B. All warranty claims must be processed through the Dealer from whom the equipment was purchased. The Dealer will co-operate with the purchaser throughout the warranty claims procedure and will arrange any necessary repairs using genuine Numatic parts.

C. If the original Dealer is no longer able to fulfil his obligations please contact Numatic International Limited with full details of the claim and proof of purchase so that this may be processed without delay.

D. Any warranty claim can only relate to the specific part that is proven to be at fault and for which a replacement will be supplied but cannot be extended to constitute a claim against the complete machine.

E. Numatic International will supply the Dealer with any warranty parts required, subject to the claim being validated, after return of the faulty items in accordance with Numatic International Limited's General Conditions of Sale.

F. Claims will not be accepted if they are the result of fair wear and tear, misuse or abuse of any kind.

G. No replacement will be given unless the appropriate evidence of the validity of the claim has been provided to the satisfaction of Numatic International Limited.

H. Numatic International Limited reserve the right to charge for any unnecessary work carried out as a result of an invalid claim.

I. No variation to this warranty may be made or implied by any member of Numatic International Limited or its Dealers unless such variation is in writing and authorised by the Company

Numatic

Numatic International Limited. Chard, Somerset, TA20 2GB

Telephone: 01460 68600 Fax: 01460 68458

© Numatic International Limited

UKCA Declaration of Conformity**Manufacturer:**

Numatic International Limited
Chard
Somerset
TA20 2GB
www.numatic.co.uk

Product:

JVP, NSP, PSP, VHN, VNP, JNP, NVP, NVH, NSH, JVH,
PSH, JNH, NUH, NPH, JDS, PRP, ERP
Vacuum Cleaner – Commercial – Dry

Description:

We, Numatic hereby declare under our sole responsibility, that the above-mentioned product(s) is/are in conformity with the following directives and standards.

S.l. 2008: 1597 Supply of Machinery Regulations EN60335-1:2012 + AC:2014 + A11:2014 + A13:2017 + A15:2021
EN60335-2-69:2012
EN62333:2008

S.l. 2016: 1091 EMC Regulations EN55014-2:12017 + A11:2020
EN55014-2:1997 + A1:2001 + A2:2008
EN61000-3-2:2014
EN61000-3-3:2013

2009/125/EC Ecodesign Requirements for Vacuum Cleaners EN60312-1:2017
(S.I. 2010:2617)

S.l. 2012: 3032 RoHS Regulations

Authorised Signatory: Mr. Matthew Coles

Position: Head of Technology
Numatic International Limited,
Chard,
Somerset, TA20 2GB, UK

Signed:  Date: 5th February 2024

EU, EC, EUE, EES: Директивата за съответствие
на машините, машините за безопасност,
Проблемът софит,
Machinery Directive
Конформитетна декларация
Overensstemmelseserklæring
Conformiteitsverklaring
Declaración de conformidad
Declaration de conformité

Manufacturer: /Производител / Hersteller / Fabricant / Fabricante / Тоолиа
/ Fabricant / Производителят / Κατασκευαστής / Gyártó / Fabricante
/ Gaminioot / Fabricant / Produzent / Fabricante / Producent /
Producteur / Proizavatelj / Tilleværdere / Proizovagialca / Valmistaja:
Numatic International Limited
Chard
Somerset
TA20 2GB
www.numatic.co.uk

Product: / Προϊόν / Термек / Prodotto / Productos / Articlel / продукт
/ Products / Produkt / Produk / Produkt / Artikeli / продукт
/ Produets / Produit / Produkts / Tröpsat / Produkts / Itzelike / Tuote:
JVP, NSP, PSP, VHN, VNP, JNP, NVP, NVH, NSH, JVH,
PSH, JNH, NUH, NPH, JDS, PRP, ERP

Description: / La description / Описание / Beschreibung / Description /
Krietas / La description / Описание / Beschreibung / Description /
Ois / Describe / Описанието / Beskrivning / Opis / Kuvatok:
Vacuum Cleaner – Commercial – Dry

EN We, Numatic hereby declare under our
sole responsibility, that the above-mentioned
product(s) is/are in conformity
with the following directives and standards.

CS My, Numatic prohlašujeme na svou
vlastní odpovědnost, že výše uvedený
výrobek(s) je/sou ve shodě s
následujícími
směrnicemi a standardy.

DE Wir, Numatic erklären in alleiniger
Verantwortung, dass das oben genannte
Produkt den folgenden Richtlinien und
Normen entspricht.

DA Vi, Numatic erklærer hermed under
egget ansvar at ovennævnte produkt(er) er
i overensstemmelse med følgende direktiver
og standarder.

ES Nosotros, Numatic declaramos bajo
nuestra única responsabilidad que el
producto antes mencionado está en
conformidad con las siguientes directivas y
normas.

ET Meie, Numatic käsitlenes kehtivate ja
kannama muuskoostis vastutusel, et esepoolne
nimetatud toode on kooskõlas järgivate
direktiivide ja
standarditega.

FR Numatic déclare sous notre seule
responsabilité que le produit mentionné ci-
dessus est conforme aux directives et normes
suivantes.

Декларация за съответствие
на машините, машините за безопасност,
Проблемът софит,
Machinery Directive
Конформитетна декларация
Overensstemmelseserklæring
Conformiteitsverklaring
Declaración de conformidad
Declaration de conformité

Manufacturer: / Производител / Hersteller / Fabricant / Fabricante / Тоолиа
/ Fabricant / Производителят / Κατασκευαστής / Gyártó / Fabricante
/ Gaminioot / Fabricant / Produzent / Fabricante / Producent /
Producteur / Proizavatelj / Tilleværdere / Proizovagialca / Valmistaja:
Numatic International Limited
Chard
Somerset
TA20 2GB
www.numatic.co.uk

Product: / Προϊόν / Термек / Prodotto / Productos / Articlel / продукт
/ Products / Produkt / Produk / Produkt / Artikeli / продукт
/ Produets / Produit / Produkts / Tröpsat / Produkts / Itzelike / Tuote:
JVP, NSP, PSP, VHN, VNP, JNP, NVP, NVH, NSH, JVH,
PSH, JNH, NUH, NPH, JDS, PRP, ERP

Description: / La description / Описание / Beschreibung / Description /
Krietas / La description / Описание / Beschreibung / Description /
Ois / Describe / Описанието / Beskrivning / Opis / Kuvatok:
Vacuum Cleaner – Commercial – Dry

BG Me, Numatic Слетиномос
че постоените две горе проповуваење е
соодветствие со сите означени директиви и
стандарти.

EL Εγώ, Numatic δηλώνω με
αποκλειστική ευθύνη μου, ότι το
αναφερόμενο προϊόν συμμορφώνεται με
τις ενοχούμενες οδηγίες, οδηγίες
και πρότυπα.

HU Mi, Numatic kijelentjük, egyedül
felelősséggel, hogy a fent említett termék
megfelel az alábbi irányelvek és
szabványoknak.

IT Noi, Numatic dichiariamo sotto la
propria esclusiva responsabilità, che il
prodotto in questione è conforme alle
seguenti direttive e norme.

LT Mes, "Numatic" pareškili višiamolukos
atsakomybes, kad pirmiau minėtas
produktas atitinka šias direktyvas ir
standartus.

NL We verklaren Numatic herbij op eigen
aansprakelijkheid, dat het bovengenoemde
product voldoet aan de
volgende richtlijnen en normen.

NO Vi, Numatic erklærer herved under
egget ansvar, at det ovennevnte produkt er
i samsvar med følgende direktiver og
standarder.

PL My, Numatic ninajszym oświadczamy z
pełnią odpowiedzialności, że wyżej
wymieniony produkt jest zgodny z
następującymi dyrektywami i normami.

RO Ne, Numatic prin prezenta declarații
prepropria răspundere, că produsul mai sus
menționat este în conformitate cu
următoarele standarde și directive.

RU Мы, Numatic оинавляем следующее
заявление исключительно, да настоящее
произведение соответствует
указанным в следующем списке
директивам и стандартам.

SV Vi Numatic förklarar här med under
egget ansvar att ovan nämnda produkt
överensstämmer med följande direktiv och
normer.

SL Mi, Numatic izjavljamo s polno
odgovornostjo, da naizpovedno
izdelan izdelki v skladu z našimi izjavljanimi
standardi.

FI Me, Numatic vakuutamme omissa
vastuulla, että edellä mainittu tuote on
yhdenmukaistettu seuraavien direktiivien ja
standardien mukaisesti.

Machinery Directive

EN60335-1:2012 + AC:2014 + A11:2014 + A13:2017 +
A15:2021
EN60335-2-69:2012

EMC Directive

EN55014-2:12017 + A11:2020
EN55014-2:1997 + A1:2001 + A2:2008
EN61000-3-2:2014
EN61000-3-3:2013

Ecodesign Requirements for Vacuum Cleaners

EN60312-1:2017

Authorised Signatory: Mr. Matthew Coles

Position: Head of Technology

Numatic International Limited

Chard,

Somerset, TA20 2GB, UK

Date: 5th February 2024

Signed: 



numatic.com

Numatic International Limited (Head Office)

Chard, Somerset TA20 2GB, UNITED KINGDOM
Tel: 01460 68600 numatic.com

Numatic International GmbH

Fränkische Straße 15-19, 30455 Hannover, DEUTSCHLAND
Tel: +49 (0) 511 984 2160 numatic.de

Numatic International Denmark

Fränkische Straße 15-19, 30455 Hannover, DEUTSCHLAND
Tel: +45 (0) 316 40808 numatic-online.dk

Numatic International S.A.S

13/17 rue du Valengelier, EAE la Tuilerie, 77500 Chelles, FRANCE
Tel: +33 (0) 164 726 161 numatic.fr

Numatic International BV

Vennootsweg 15, 2404 CG, Alphen aan den Rijn, NEDERLAND
Tel: +31 (0) 172 467 999 numatic.nl

Numatic International Schweiz AG.

Sihlbruggstrasse 3A, 6340 Baar, SCHWEIZ
Tel: +41 (0) 41 768 0760 numatic.ch

Numatic International (PTY) Ltd.

Cnr. 16th & Pharmaceutical Road, Randjes Park, Midrand 1685, SOUTH AFRICA
Tel: +27 (0) 861 686 284 numatic.co.za

Numatic International ULDA

Rua Francisco da Silva Duarte, nº79,
4475-269 Santa Maria de Avioso, Castelo da Maia, PORTUGAL
Tel: +351 220 047 700 numatic.pt

NUMATIC INTERNATIONAL SPAIN, S.L.U.

Av. Baix Llobregat, 5-7, Oficina bajos 1 (Parc Negocis Mas Blau II),
08820 El Prat de Llobregat (Barcelona) SPAIN
Tel: +34 93 647 22 22 numatic.es

Numatic International Italy S.R.L

Via Luigi Galvani, 2, Z.I. Talponedo, 33080 Porcia (PN), ITALY
Tel: +39 (0) 434 046 211 numatic.it

Specification subject to change without prior notice
numatic.com © Numatic International Limited